

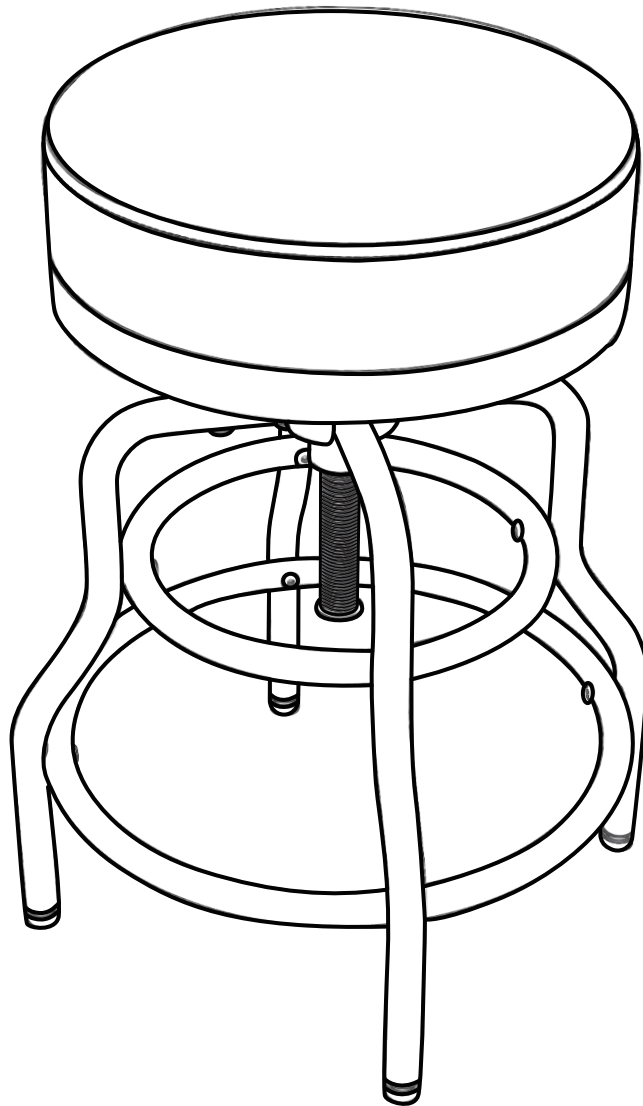

**RAYNESYS**

# User Manual



---

Bonded Leather Upholstered Round Barstool

# IMPORTANT NOTICE

Dear customer:

If you receive a product with missing or damaged parts, or if you have any questions about the barstool, please contact Raynesys customer service mailbox for feedback, and we will give you a satisfactory solution.

We are very sorry for the possible inconvenience, and thank you for your understanding and support. Raynesys wishes you a happy life.

You can contact us by following ways:

(1)Raynesys customer service mailbox:

[support@iRaynesys.com](mailto:support@iRaynesys.com)

(2)Contact us on Amazon: From your Amazon order details page, select

“Order” >> “Sold by” >> “Contact seller”.

**⚠️ Attn:**

**1.Do NOT let your kids climb on the barstool!**

**2.Prevent children from ingesting anti-mold chip and desiccants in the package!**

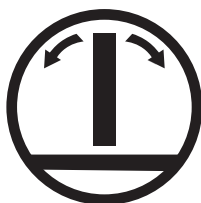

Prevent Collapse



No Climbing







No Dragging



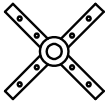
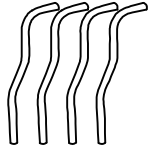

# MAINTENANCE ADVICE

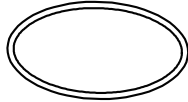
1. Please use a soft cloth or clean damp cloth for cleaning. Do NOT use bleach or abrasive cleaners.
2. Please store in a dry and cool area, avoiding high temperatures and direct sunlight to protect the finish.
3. Do not allow dirt to remain on the surface for a long time.
4. Please use a damp and clean cloth to immediately absorb any spilled liquid.
5. Do NOT lean with products containing the following: acetone (e.g., nail varnish remover), ammonia (e.g. bleach), or sodium hydroxide (e.g., caustic soda, drain, and oven cleaners).
6. Please check whether there are missing screws in the product regularly.
7. The product should NOT be discarded with household waste, and please take it to your local authority waste disposal center.

# PARTS LIST

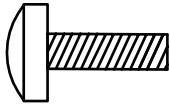
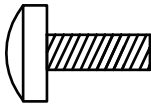
A(x1)		B(x1)		C(x1)	
Barstool Seat		Central Support Rod		Fixed Nut with Rod	
					
D(x1)	E(x4)	F(x1)		G(x1)	
Barstool Leg Connector	Barstool Leg	Small Ring Footrest		Large Ring Footrest	
					

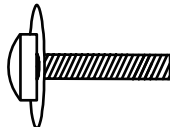
# HARDWARE LIST

H(x4)		I(x8)		J(x8)	
Screws M6*20		Screws M6*16		Screws M6*35	
					
K(x1)		L(x1)		M(x1)	
Screw with Washer		Screw Wrench		Decorative Cover	
					

# ASSEMBLY STEPS

## ! Please Note:

Please tighten the screws of the barstools for 6 months or irregularly.

The installation requires a lot of screws, it is recommended to use an electric drill to install.

## Step 1

Assemble the central support rod (B) to the barstool seat (A) with M6\*20 screw (H).

**Note:** Tighten the screws to a depth of 70%.

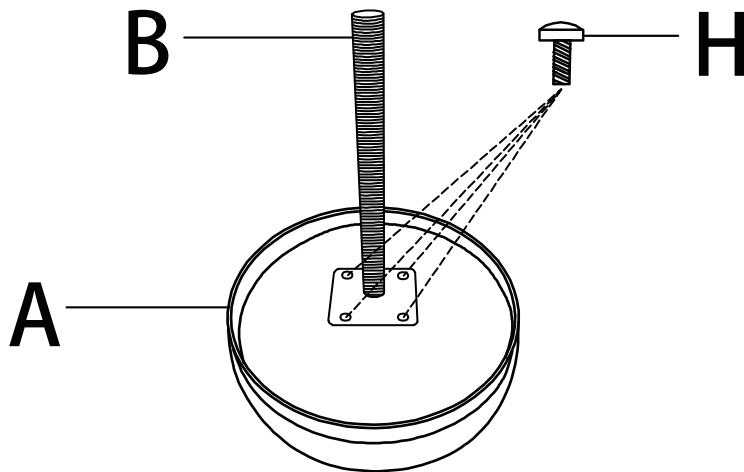

---

## Step 2

Rotate fixed nut with rod (C) to assemble it with central support rod (B).

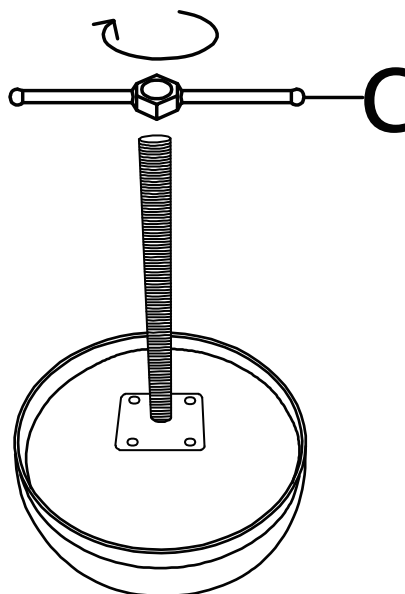

## Step 3

Assemble the barstool leg (E) to the barstool leg connector (D) with M6\*16 screw (I).

**Note:** Tighten the screws to a depth of 70%.

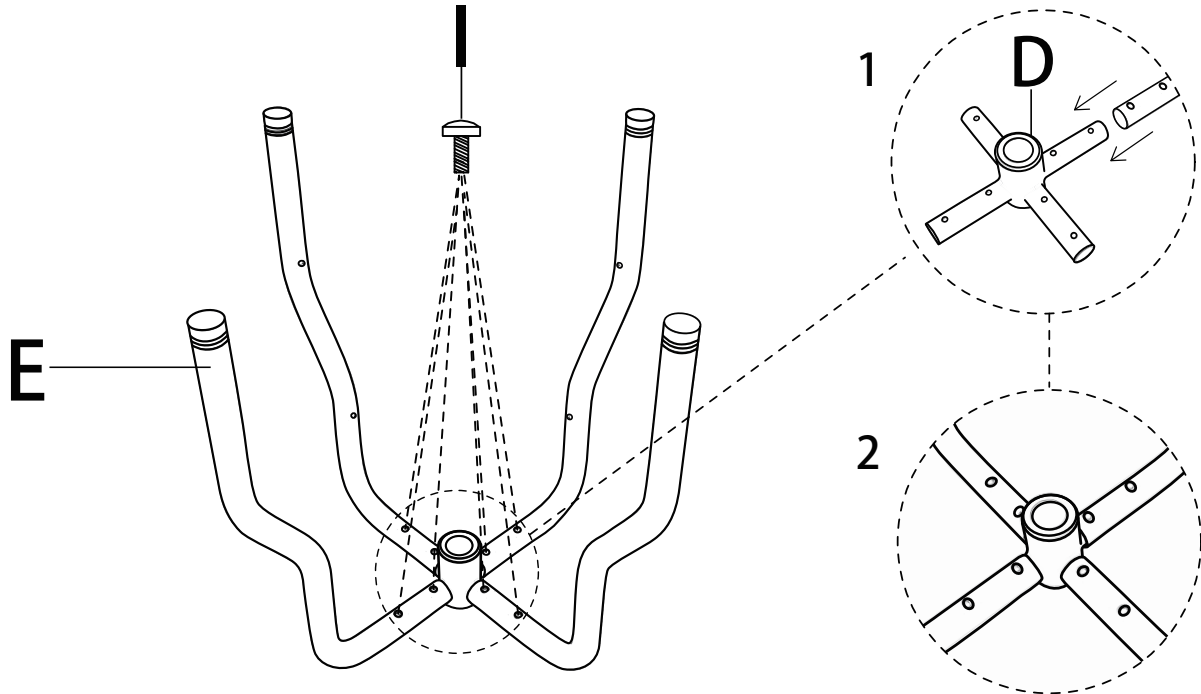

---

## Step 4

Assemble the small ring footrest (F) to the barstool leg (E) with M6\*35 screw (J).

**Note:** Tighten the screws to a depth of 70%.

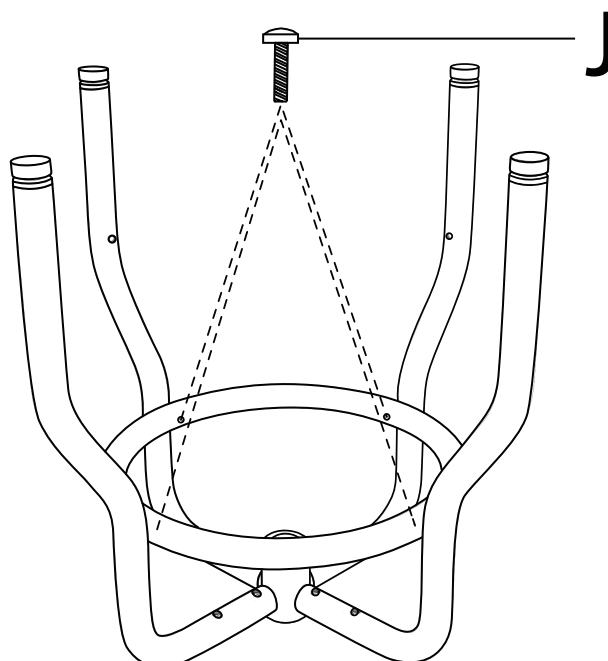

## Step 5

Assemble the large ring footrest (G) to the barstool leg (E) with M6\*35 screw (J).

**Note:** Tighten the screws to a depth of 70%.

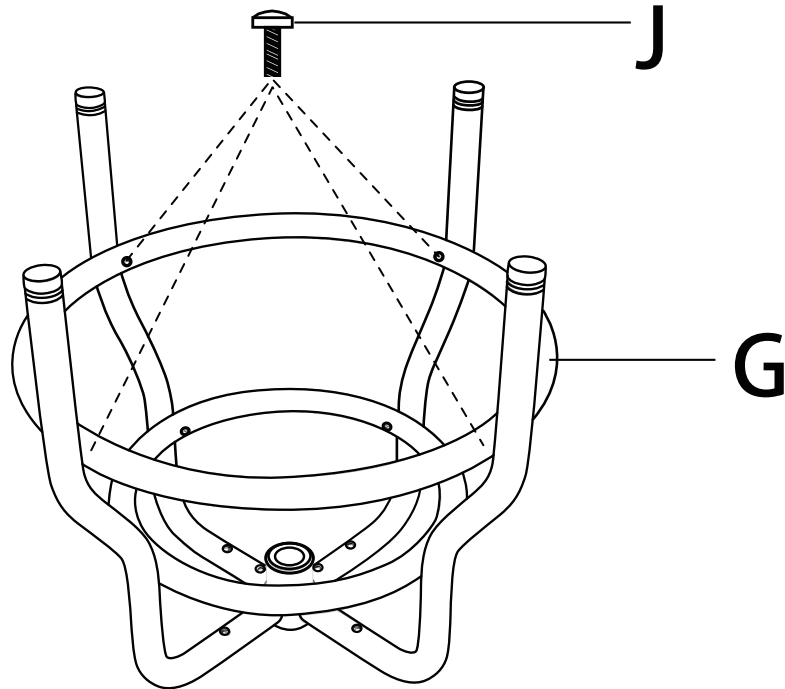

---

## Step 6

Align the opening of decorative cover (M) to iron pipe, and snap with a gentle pressure.

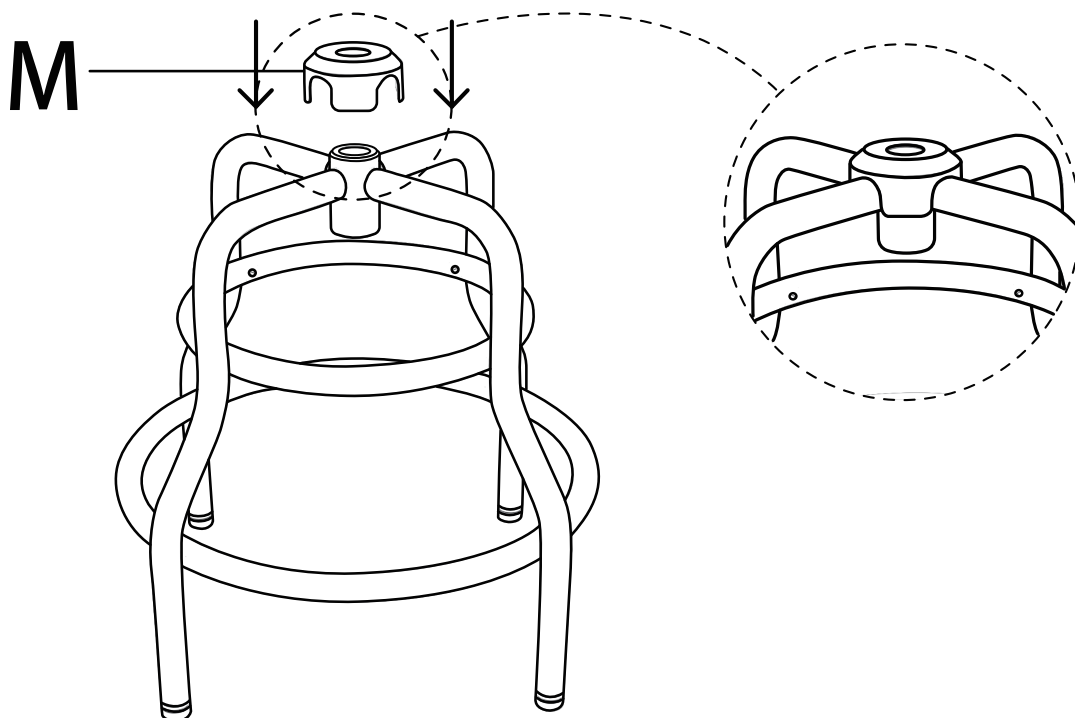

## Step 7

Align the hole, rotate the part of barstool seat to assemble with the part of barstool leg.

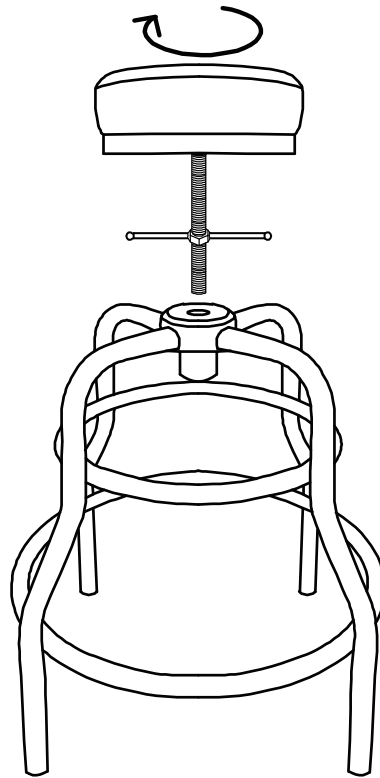

---

## Step 8

Assemble the screw with washer (K) as picture shown.

**Note:** Align the screw holes and tighten them to 70%. Please check and then tighten them all to 100%.

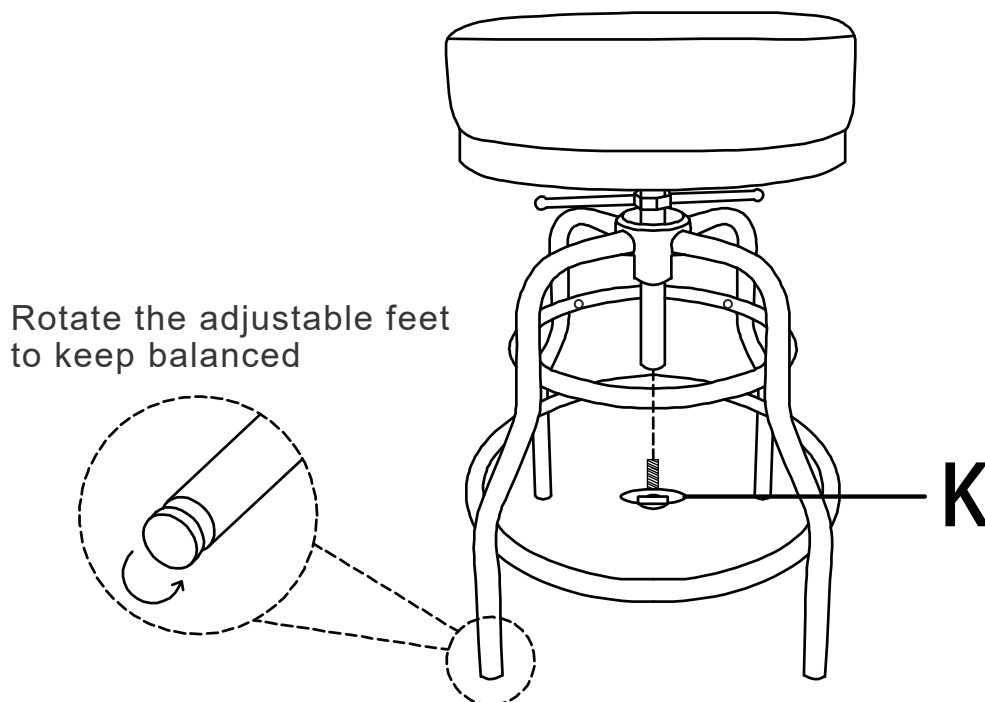

## Step 9

Check whether the barstool is stable and then ready to use.

**Note:** Check whether all screws are tightened before use.

